

(1) X 1	
(2) X 2	
(3) X 10 (6X16)	
(4) X 1	
(5) X 10 (8X16)	
(6) X 16	
(7) X 4	
(8) X 1	

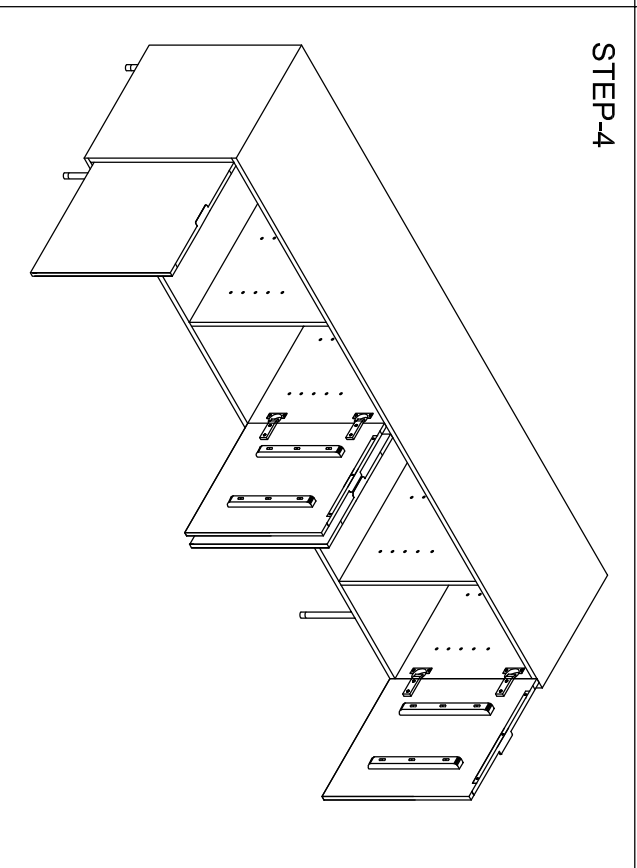

STEP-5

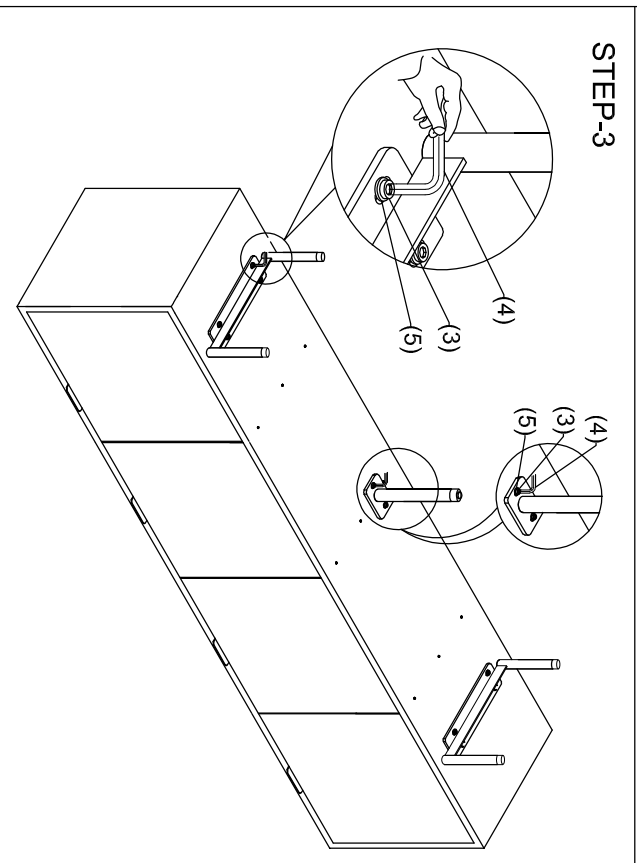
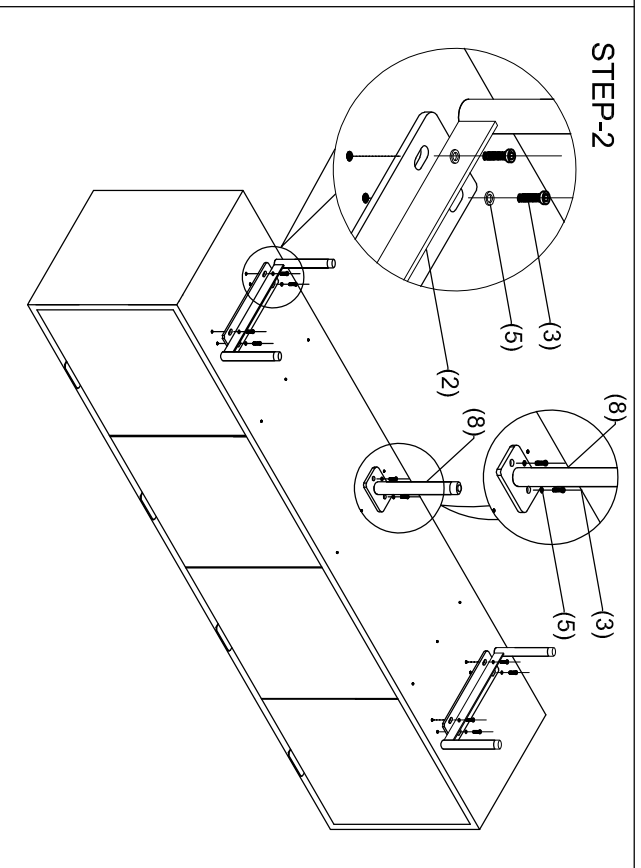
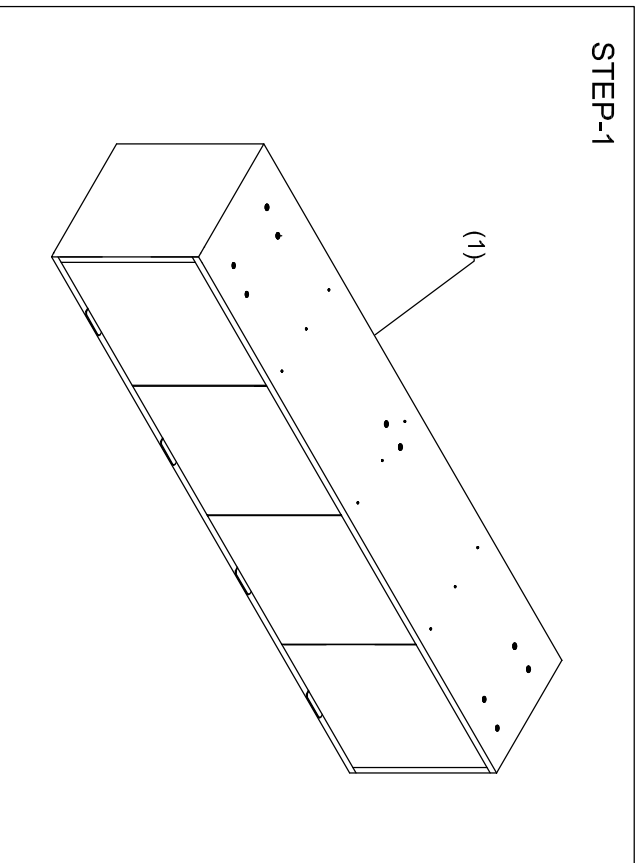
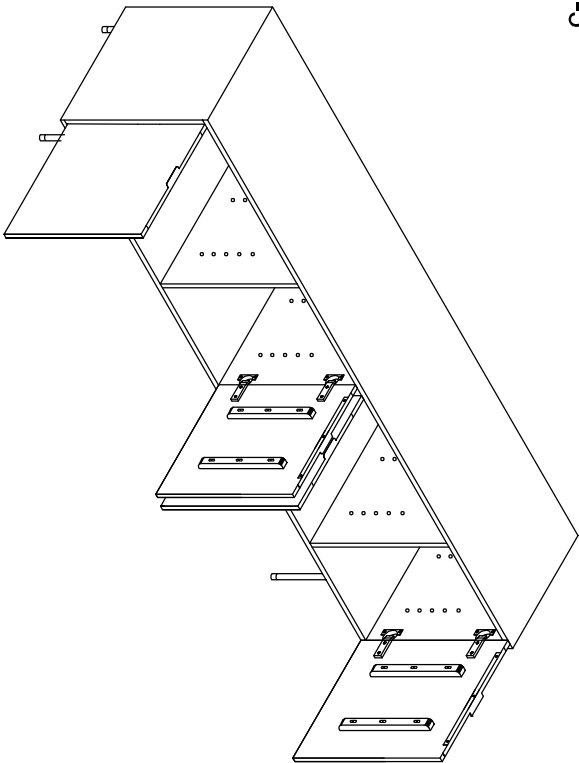

STEP-6

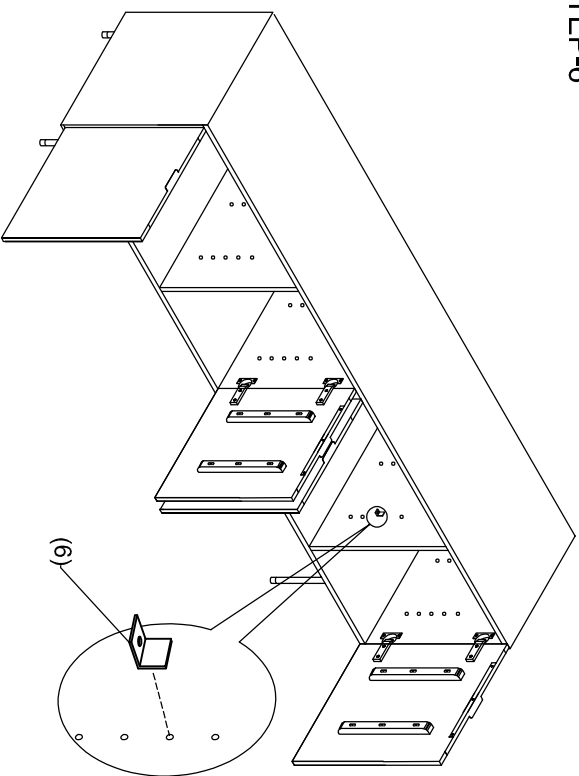

STEP-7

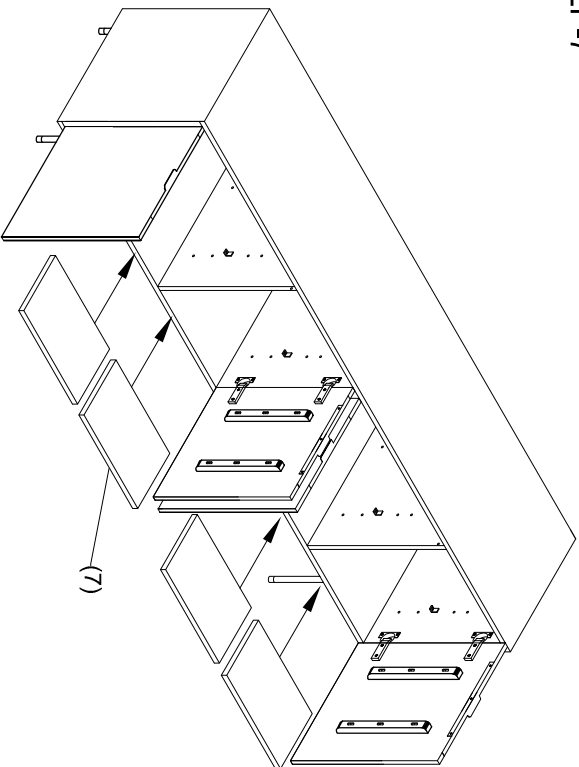

STEP-8

